

EasyTrainer 40

Assembly Instructions



Item No. 4564/4566

EasyTrainer 40^{PLUS}



Item No. 4565/4567

WARRANTY

Thunder Tiger Model Company guarantees this model kit to be free from defects in both material and workmanship at date of manufacture. This warranty does not cover any components damaged by use or modification and in no case shall Thunder Tiger's liability exceed the original purchase price of the kit. Thunder Tiger also reserves the right to change or modify this warranty without notice.

Since Thunder Tiger Model Co. has no control over possible shipping damages or construction techniques and materials used for construction by the modeler, no liability can be assumed nor accepted for damage resulting from the use by the user of the final user-assembled product. By the act of using this user-assembled product, the user accepts all resulting liability. If the buyer is not prepared to accept this liability, he should return this kit in new and unused condition to the place of purchase for a full refund.

INTRODUCTION

All of us at Thunder Tiger want to thank you for choosing the best looking, easiest building and best flying ARF trainer available the...EasyTrainer 40. This kit features state-of-the-art engineering that provides quick and easy assembly of a strong, yet lightweight airplane that will give you an enjoyable and educational experience.

To gain the most from this airplane kit, it is important that you read the instructions thoroughly and then follow them exactly. This instruction manual has been written with a novice modeler in mind, but includes many hints and modeling tips that even experienced modelers can benefit from. We strongly suggest that you read through the instructions completely before beginning construction. This will give you a good idea of the construction sequence and eliminate many questions you might have if you did not read the manual prior to starting the actual construction.

The first thing you should do before beginning assembly is to check the contents of your kit against the parts list on pages 4 and 5. If any parts are missing, contact your dealer immediately for replacement. Customers in the United States and Canada may contact **Ace Hobby Distributors at 2055 Main Street, Irvine, CA 92614** 1-949-833-7498 for replacement parts. *Under no circumstances can a kit be returned if assembly has already been started.*

TABLE OF CONTENTS

Introduction	2
Other Items Required	2
Items Need Check List	3
Parts List	4-5
Pre-Assembly Notes	6
Wing	6-8
Fuselage	9-10
Install the Engine	10
Install the Fuel Tank	11
Tail	12-14
Install the Radio	14-16
Final Assembly	17
Flight	18-20

OTHER ITEMS REQUIRED FOR ASSEMBLY

A checklist is also provided on the next page which will make shopping for these items easier.



Radio - A 4-channel radio with four standard servos is required. Most lower priced 4-channel radios only come with three standard servos so you may need to purchase the fourth servo separately.

EasyTrainer 40





Adhesives - You will need two types of adhesives for the Pegasus - Epoxy and Instant (cyanoacrylate) adhesives. We recommend that you purchase both 5-minute and 30-minute epoxy to cut down on assembly time, but you can get by with only 30-minute epoxy if time is not important. You will also need a small bottle of both "Thick" and "Thin" instant adhesive.



Tools - Model assembly can be much easier if the proper tools are used. Therefore, we have included in our checklist to the right, a complete listing of all the tools we used to assemble our prototype models. As you will notice, many household tools can be utilized during construction.

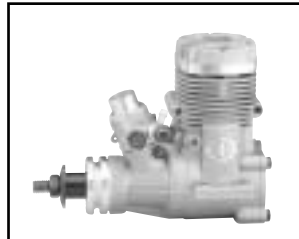
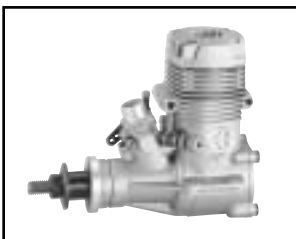

Engine - The Thunder Tiger GP-42, PRO-40, PRO-46 and F-54S are the ideal engines for this airplane. These quiet running engines are easy to start, require no special break in periods, are very easy to maintain and will last for years.

Flight Equipment - There are several "support" items that you will need to purchase in order to get your engine running and your plane in the air. These are listed at the bottom of the page.



Comprehensive Items Needed Check List

- 4-Channel Radio with 4 Standard Servos
- 5-Minute Epoxy (4 ounces or so)
- 30-Minute Epoxy (4 ounces or so)
- "Thin" Instant Adhesive (1/2 ounce)
- "Thick" Instant Adhesive (1/2 ounce)
- Hobby Knife and Blades
- Epoxy Mixing Sticks and/or Brushes
- Sandpaper (150 grit)
- Masking Tape
- Rubbing Alcohol
- Paper Towels
- Ruler
- 90 Degree Triangle
- Waxed Paper
- Fine-Point, Felt-Tip Pen
- Misc. Household Tools
- Drill and Bits (1/16", 5/64", 3/32")

Flight Equipment

- Foam Rubber Padding for the radio
- Stick on Lead Strip for balancing the plane
- 3 or 4 Props (see engine instructions)
- 10%-15% Glow Fuel
- Fuel Pump or Bulb
- Electric Starter or "Chicken Stick"
- Glow Plug Clip and Battery
- Extra Glow Plug(s)

ORDER BY BAG NUMBER ONLY
INDIVIDUAL PARTS NOT AVAILABLE

AS6205 Windshield (#4564/#4565)
AS6214 Windshield (#4566/#4567)

Wood Screw
2 x 5mm(8)

Windshield(1) Black Windsow(1)

AS6204 Rudd./Elev. Pushrod (#4564/#4565)
AS6213 Rudd./Elev.Pushrod (#4566/#4567)

Clevis(2)

Pushrod(2)

3102 Adjustable Engine Mount

Beams(L/1 R/1)

Engine Mount Plate(1) Nose Gear Mount(1)

Screw
3 x 15mm(4)

Screw
6/32 x 18mm(6)

PE0009 Hardware Set

Push Rod Connector(2) Allen Wrench(1)

2mm Hex Nut(2) 2mm Washer(2) 3 x 3mm Set Screw(2)

3282W Spinner

3 x 12mm
Self-Tapping Screw

Backplate(1) 2" Spinner(1)

3263 Fuel Tank

Silicone Tube(1) Straight Nipple(1) Cap(1)

90-degree Nipple(1) Clunk(1) Rubber Stopper(1)

3255 Wheels

Wheel(3)

3150 Control Horn

2 x 12mm Screw(4)

Nut Plate(2) Control Horn(2)

300cc Fuel Tank(1)

AS6203 Landing Gear

Steering Collar(1) Steering Horn(1) 3 x 5mm Screw(6)

Nose Gear(1)

Mounting Strap(2) 3 x 10mm
Self-Tapping Screw(4) Collar(5)

Main Gear(2)

AS6206 Decal
(#4565/#4567 ONLY)

EasyTrainer
EasyTrainer EasyTrainer

Decal(1)

ORDER BY BAG NUMBER ONLY
INDIVIDUAL PARTS NOT AVAILABLE

- AS6200 Fuselage 40T (#4564)**
- AS6210 Fuselage 40H (#4566)**
- AS6207 Fuselage 40T Plus (#4565)**
- AS6215 Fuselage 40H Plus (#4567)**

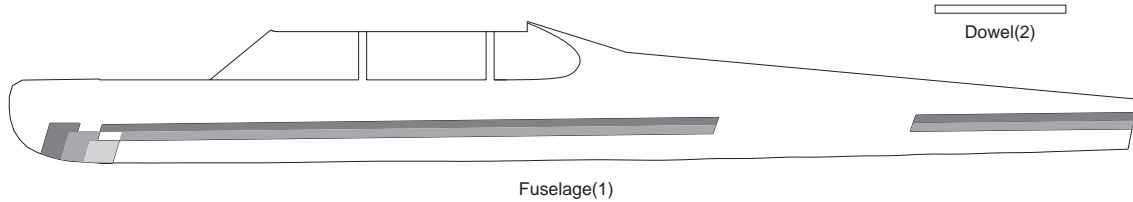

- AS6201 Main Wing 40T (#4564, Flat Bottom)**
- AS6211 Main Wing 40H (#4566, Semi-Symmetrical)**
- AS6208 Main Wing 40T Plus (#4565, Flat Bottom)**
- AS6216 Main Wing 40H Plus (#4567, Semi-Symmetrical)**

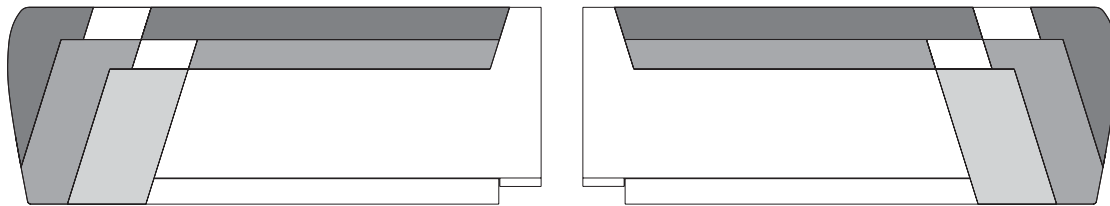

- Trim Tape(1)
- Aileron Servo Tray(1)
- Wing Protector(1)
- Wing Joiner(3)
- Aileron Torque Horn(2)
- CA Hinge(8)

3152 Aileron Pushrod



PE0577 Forward Pushrod

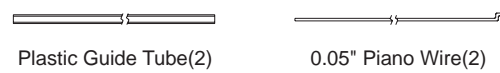

- AS6202 Tail Feathers 40T (#4564)**
- AS6212 Tail Feathers 40H (#4566)**
- AS6209 Tail Feathers 40T Plus (#4565)**
- AS6217 Tail Feathers 40H Plus (#4567)**

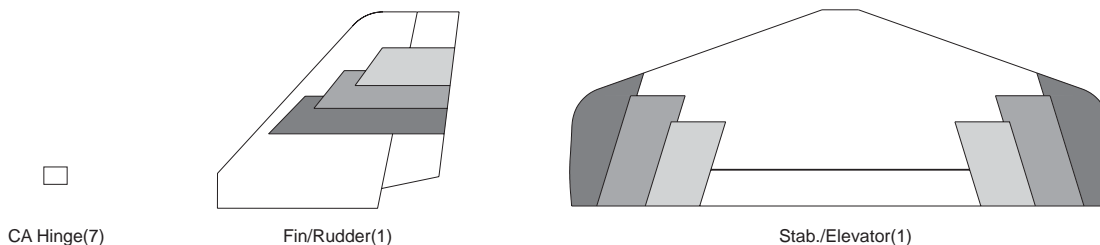

PRE-ASSEMBLY NOTES

1. If you are not an experienced R/C pilot, plan to have a fully competent pilot check your completed model and help you with your first flights. Even though we have tried to provide you with a very thorough instruction manual, R/C models are rather complicated and an experienced modeler can quickly check over your model to make sure your first flights are successful.

2. Please assemble your model according to these instructions. Do not attempt to modify or change in any way as doing so may adversely change its flying characteristics.

3. Before you begin, please check the entire contents of this kit against the parts list and photo to make sure that no parts are missing or damaged. This will also help you to become familiar with each component of your plane. If you find that any of the parts are either missing or damaged, please contact your dealer immediately for replacement.

Note: Your dealer cannot accept kits for return if construction has begun.

ASSEMBLY

Note: Each step of these instructions is preceded by a box which can be checked off as you complete the step. This will allow you to follow your progress and quickly find your starting place after any interruptions or breaks.

WING ASSEMBLY

Open the small wood parts bag and remove the three 1/8" plywood wing panel joiners. Gently sand the edges to remove any rough edges.



Mix up some 5-minute epoxy and apply it to both sides of one of the joiners. Sandwich this piece between the other two joiners and align the edges of all three joiners.

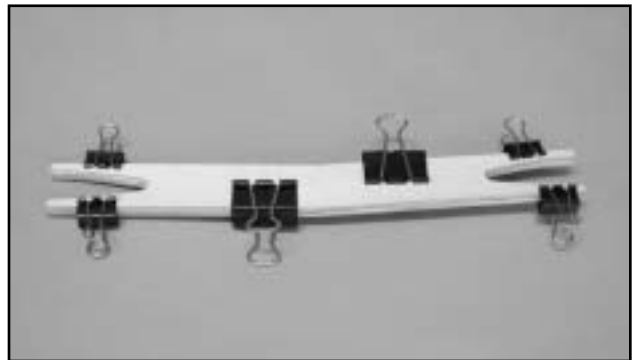

Clamp the three joiners together with clothespins or other small clamps and wipe off the excess epoxy before it cures. Allow the epoxy to cure before removing the clamps.



❑ On the bottom of one wing half, make a mark $\frac{3}{8}$ " (10mm) from the inside edge of the wing, between the pre-cut slot in the center rib and the rear edge of the spar box. Use a hobby knife to cut away the covering and balsa sheeting in this area.

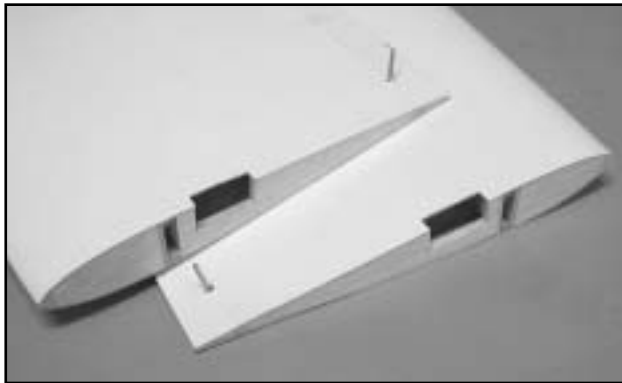

❑ Also remove the portion of center wing rib in this area to allow clearance for aileron servo. Repeat the same process on the other wing half.

❑ Before gluing the two wing halves, trial-fit the wing joiner into both wing panels. If it is not easy to slide into the wing, sand it until it will. To fit properly, note that the wing has an upward "bend" in it; this is called dihedral.

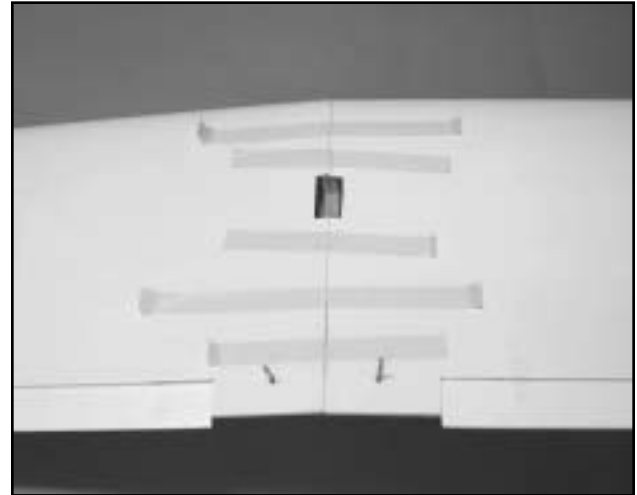

❑ With 30 minute epoxy, liberally coat all sides and edges of the wing joiner and slip it into one wing half. Now coat the inside edge of the center wing rib where it will join to the other wing half. This is called the "root" of the wing.

❑ Join the two wing halves and firmly press wing panels together. Wipe off any excess epoxy with a paper towel and rubbing alcohol. Make sure the two panels are accurately aligned with each other and hold together with several strips of masking tape.



❑ Place the servo tray centered over the cutout in the bottom of the wing. Mark around the servo tray with a pencil.

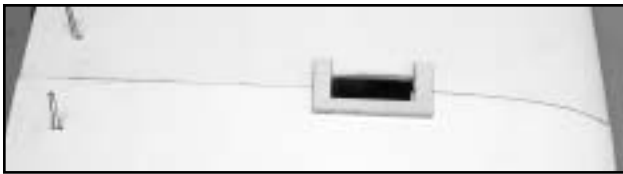
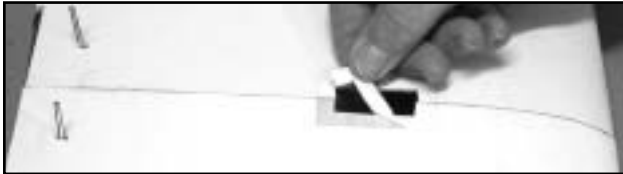
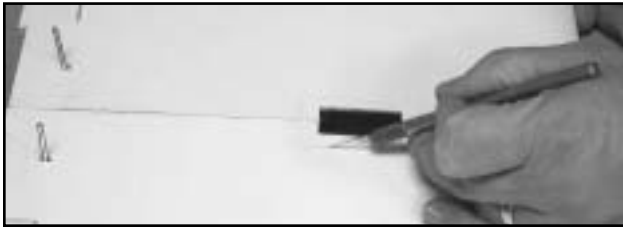

❑ Remove the tray, and use a sharp knife to score the covering material where marked. Remove the covering material to expose the wood underneath. Use thick CA or epoxy to glue the servo tray securely in place.



❑ Locate the white trim tape and apply to center wing joint. Start at the servo tray and work around the wing. Gently pull on the tape while pressing it down onto the wing to slightly stretch the tape into place and provide a smooth seam. You will have to use Heat Iron to iron the trim tape if you have Ultracote covered Trainer.

❑ Lightly sand the edges and one side of the plastic wing protector to remove any roughness and help the glue stick to the plastic. Use thick CA or epoxy to glue the wing protector to the

top surface of the wing so it is centered over the wing joint and flush with the wing trailing edge.



❑ To hinge the ailerons, remove the clear tape that holds one of the ailerons in place. Pull the aileron off the wing, revealing four hinges. Center these hinges in their slots in the AILERON and secure them with THIN CA, letting it wick into the joint. Glue both sides of the hinge.



❑ When the glue has set, re-install the aileron onto the wing. Hint: if you trim a little bit off each corner of the hinges, they will insert in the slots easier. While flexing the aileron one way or the other and while holding the wing up on it's front edge, carefully wick CA into the slot where the hinge goes into the wing. Do so on both sides of the hinge. After the glue has set, tug on the aileron at each hinge location to make sure the hinges are securely glued in place. Also, make sure the aileron is free to move up and down.

Note: you can remove any residue from the tape with alcohol.

Set your wing aside, for now.

FUSELAGE ASSEMBLY

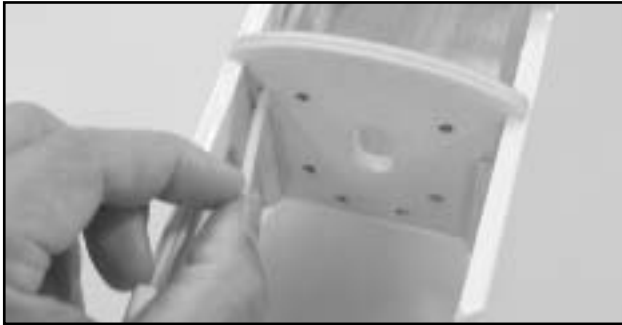

❑ Insert the throttle tubing first. It runs along the right side of the fuselage and goes from the up corner of the firewall back through the right hole in the first former and then through the right hole in the second former. Glue it securely in place with thick CA.

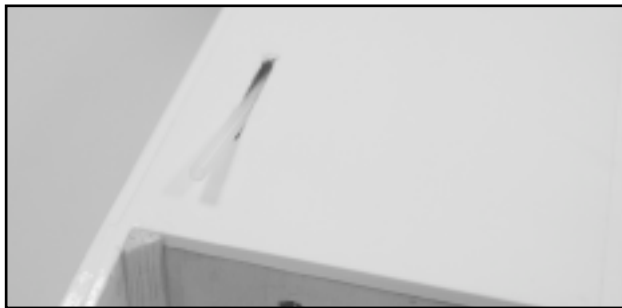

❑ Same way to the nosegear tubing. You will have to use hobby knife to cut away the covering then insert the tube through the first former and second former. Glue the tube in place with thick CA.

INSTALL THE MAIN GEAR



❑ Locate the main landing gear channel in the bottom of the fuselage. Use a sharp hobby knife to remove any covering from the slot. You might lightly coat the exposed wood in the landing gear slot with 5-minute Epoxy to prevent the wood from becoming fuel soaked.

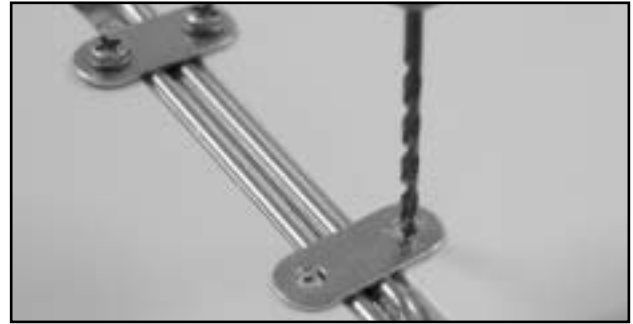

❑ Position the two metal landing gear straps across the landing gear struct. Using a felt tipped pen, mark the location for the four landing gear mounting strap holes. Drill the four mounting holes as marked with 3/32" drill bit. Secure the mounting strap by four 3 x10 screws.



❑ Install the wheels onto the main gear using the supplied wheel collars and 3 x 5mm screw. Make sure the wheel rotates freely.

INSTALL THE ENGINE



❑ Attach the engine mount plate, both mounting beams and the nose gear bearing to the fire wall using the 6-32 x 18mm screws provided. Make sure the mounting beam "webs" are near the outside of the mount. It is not necessary to fully

INSTALL THE ENGINE



tighten the four engine mount screws at this time. Also temporarily install the nose gear, using the steering arm to secure it. A special collar and phillips head set screw inserts in the steering arm which secures it to the nose gear. The set screw should contact the "flat" that is ground into the nose gear. Note the orientation of the coil on the nose gear. The nose wheel is secured with two wheel collars and phillips head set screws.



□ Set the engine on the mount and adjust the beams, if necessary, so that they are almost touching both sides of the engine crankcase and are centered in relation to the engine mount back plate. Now position the engine so that the front of the thrust washer is approximately 4" from the fire wall. Note: you will probably have to trim away the fuselage side for needle valve clearance.



□ Remove the engine and drill a 3/32" hole at each of the four marks you just made. "Break-in" the mounting holes by inserting a 3 x 15mm sheet metal screw into each hole without the engine in place. A drop of oil in each hole may help the screws thread in easier.



□ Using either Z-bend pliers or a regular pair of pliers, make a "Z" bend in one end of one .050" piece of wire. Slide it into the throttle linkage tube.

□ Hook the "z" bend onto your engine's throttle arm and move the engine into position. You may have to bend some jogs in the wire to prevent binding of the linkage. Screw the engine in place on the mount.

Trim the fuselage side as needed for muffler clearance. Coat any exposed wood with epoxy or CA. Install the muffler.



□ In a similar fashion, make a "z" bend in the remaining piece of .050" music wire for the nose gear steering arm. You will need to remove the nose gear so the steering arm is loose and the "z" bend can engage the outer hole of the arm. Slide the music wire into the outer tube and re-install the nose gear. Make sure the 3 x 5mm set screw firmly tightens on the "flat" that is ground on the nose gear. Rotate the nose wheel back and forth a few times to make sure it rotates freely without binding. You may need to bend the pushrod wire slightly to eliminate any binding in the pushrod. If the alignment between the nose gear bearing and the engine mount seems to be causing some binding, loosen the mounting screws and adjust the mounts until it rotates smoothly.

INSTALL THE FUEL TANK



❑ Assemble the fuel tank by first cutting the silicone tube to 2-1/2" in length. Press the straight plastic nipple (the 90 degree nipple is not used in this plane) into the rubber stopper (Saliva will ease insertion.) Now slip the silicone tubing onto the nipple and insert the metal clunk into the other end of the tubing. Insert this assembly into the tank (clunk first) and securely tighten the threaded cap on to hold everything together.



❑ Attach a 6" piece of standard fuel line (not furnished) to both the fuel outlet nipple and the vent nipple on the tank.

❑ Slide the fuel tank (cap end first) into the front of the fuselage, threading the fuel lines through the oblong hole in the firewall. The tubing coming from the tank's fuel outlet (center) goes to the carb and the tubing from the vent (upper) goes to the muffler's pressure fitting. Trim the length as needed. The tank fits tightly in the former.



❑ Locate the windshield and window. Trim the windshield and window along with the molded cutting line with curved scissors.



❑ Put the windshield on the front fuselage. It is held in place with eight 2 x 5 wood screws. You will need to drill a 1/16" pilot hole for each screw first. Glue the window onto the windshield with CA.

INSTALL THE TAIL GROUP

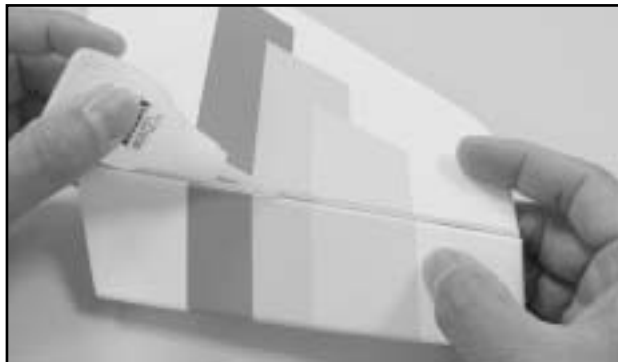
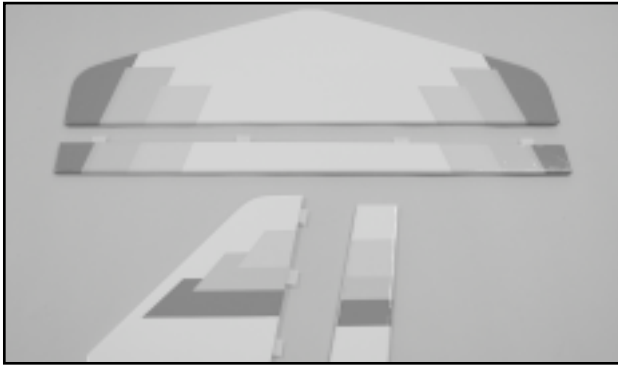

- ❑ Remove the elevator and rudder and glue the hinges into the control surfaces using the same technique outlined for the ailerons.



- ❑ Trim away the covering from the slot at the rear of fuselage where vertical fin and horizontal stab go.

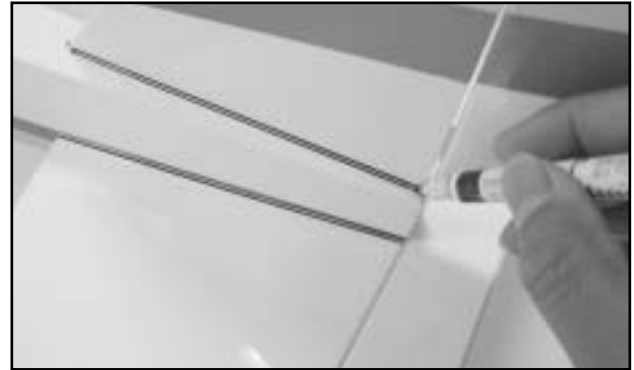

- ❑ Use ruler to decide the center of stab and make marks. With the main wing centered on the fuselage, position the horizontal stab first then you can see the marks you drew through the slot. Then, position vertical fin. Use a felt tip pen or marker to draw lines along the fuselage sides. Do not forget draw lines at the bottom side of stab.

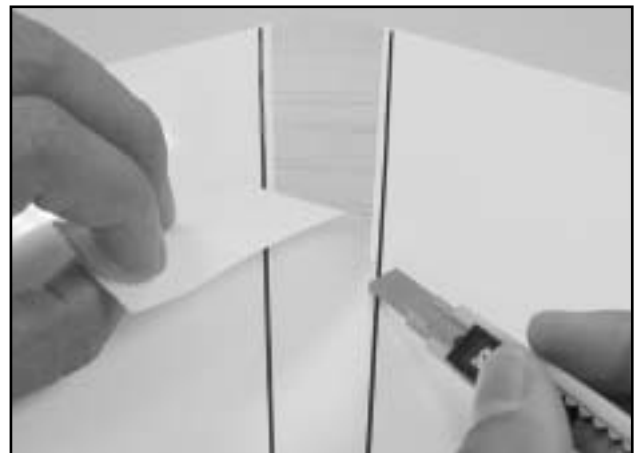

- ❑ Remove the stab and fin from the fuselage and use a hobby knife to carefully score the covering material where marked. Make the score approximately 1/16" inside the lines you drew. It is very important that you do not press hard enough to cut into the wood itself or the stabilizer may fail in flight. Just score the covering and it will peel away nicely. In a similar fashion, remove the covering material on the vertical fin.

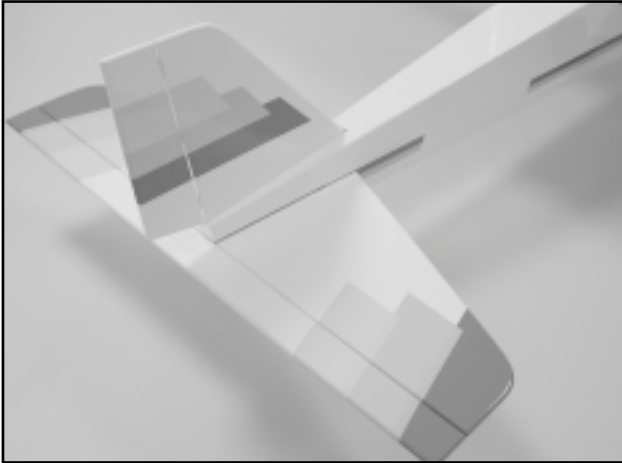

❑ Glue the stab and fin to the fuselage with epoxy, keeping the stab and fin in position as diagram shown.

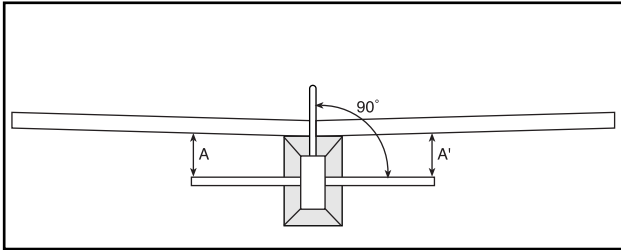

The fin is perpendicular to the stab. Both stab tips to the main wing are equal from the rear view ($A=A'$)

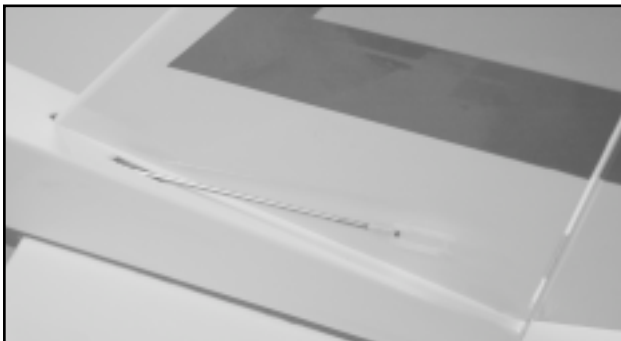

❑ Remove the covering on the slot. The rudder and elevator pushrods have already been pre-assembled at the factory. Insert the rudder pushrod which is bent at the thread end, thread end first, into the fuselage and exits the slot on the top of the rear fuselage. Locate the clevis, thread the clevis onto the threaded end at least 1/4" in length.



❑ Locate the control horns and 2x12mm screws. Snap the clevis onto the control horns. Now position this horn onto the Rudder in such a way that the nyrod runs straight and the holes in the control horn are in line with the hinge line of the stabilizer. Mark the location of the control horn mounting holes on the elevator. Next, drill 5/64" holes where marked.

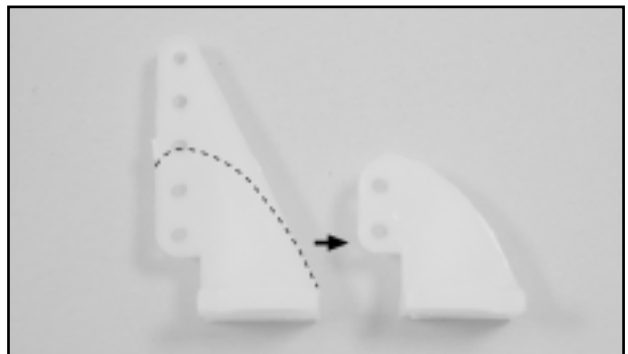

❑ Cut the control horn as photo shown.

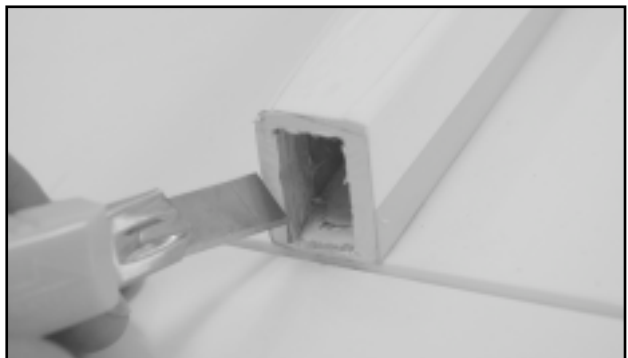

❑ Carefully cut a hole with hobby knife at the tail as the elevator pushrod exit.



□ Use control horn as template and drill 5/64" holes with the control horn in line with the hinge line of elevator and right at the pushrod exit.

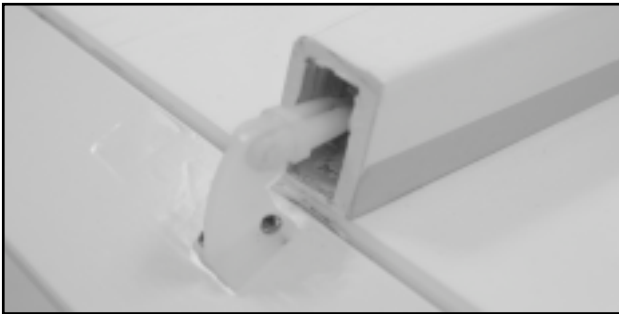

□ Mount the control horn with 2 x 12mm screws. Insert the elevator pushrod with clevis threaded on. Cut a small piece of silicone and slide it onto the clevis. Then, snap the clevis on the outmost hole of control horn.

INSTALL THE RADIO

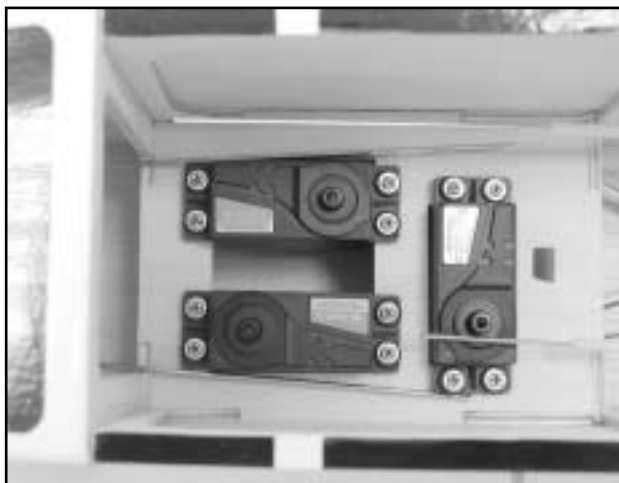

□ Mount three servos on the servo tray which is already installed in your fuselage. Note their orientation in the photo. Follow your radio's instruction manual and make sure you use the grommets, eyelets, and screws furnished with your radio. Drill 1/16" pilot holes for the mounting screws before insertion.

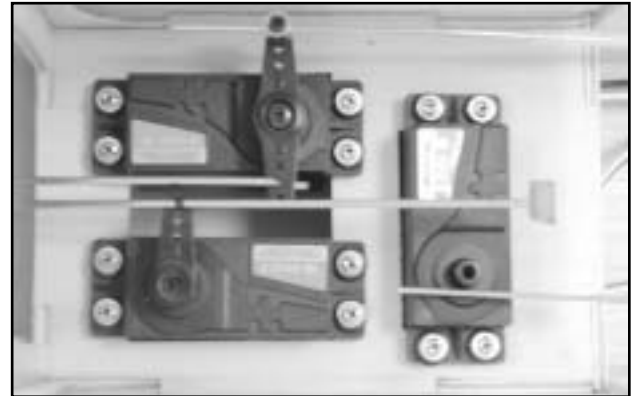

□ Now it is time to hook the servos up to the control surfaces. Using Z-bend pliers, makes a Z-bend at the marked location. Cut off the excess rod. Insert the Z-bend into the servo arm .



□ Install the pushrod connector onto the outermost hole in the rudder servo arm and throttle servo arm as shown.

To do so, remove the servo arm from the servo place the pushrod connector so the threaded portion exits the bottom of the servo arms. Secure in place using a 2mm washer and nut.

Note: Ensure that the hole for the pushrod wire is parallel to the length of the fuselage. Align the pushrod tube with the servo. The pushrod tube should not extend all the way to the servo as this would cause the pushrod to bind during operation. To shorten the pushrod tube, remove any excess length with a sharp hobby knife accordingly. Insert the pushrod wire through the pushrod connector. Secure in place using a 3mm set screw.

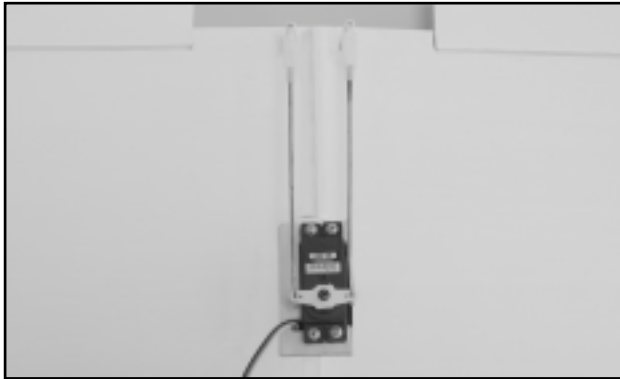

□ Hookup to the ailerons is via a nylon horn that is threaded onto the torque rod that is already installed in the wing. Screw the horn down until there is about 1/16" of threads exposed above the horn. Use threaded rods with clevises on the end for the linkage. Bend a "z" bend on the servo end of the rod at the proper length so you have neutral aileron when the servo is centered.



□ Using the switch cover as a template, cut an opening in the side of the fuselage to mount the switch in. It should be on the left side of the fuselage. Drill two 1/16" holes for the switch mounting screws and install the switch.
 □ There are 1/4" holes in both fuselage sides in front of and behind the wing opening for the wing hold-down dowels. Cut the covering away from these holes and install the two wing hold-down dowels in these holes.



□ Wrap your receiver and battery with packing foam which is available at local hobby shop. Install the receiver and battery in the front of the servo tray. Receiver is near the servo tray and battery is far from the servo tray as shown.
 □ Drill a 1/16" hole through the fuselage side, about one inch behind the switch mount. From the inside out, thread the receiver antenna through this hole. You may want to tie a knot in the antenna 3" or 4" from the receiver to act as a strain relief. Attach the end of the antenna to the top of the vertical fin with a small #10 rubber band and a T-pin. Maintain only a slight amount of tension on the antenna wire.

□ Correctly install the prop in front of the spinner backplate using the engine prop washer and prop nut. Note that the spinner backplate has two little posts that must be rotated up against the prop blade before the spinner will fit on. Rotate the prop counter clockwise until it is vertical when it is against the engine's compression stroke. Securely tighten the prop nut using a prop wrench or correctly fitting wrench. It is not a good idea to use pliers when tightening the prop nut! Attach the spinner to the spinner backplate using the two 3 x 12mm self tapping screws provided.



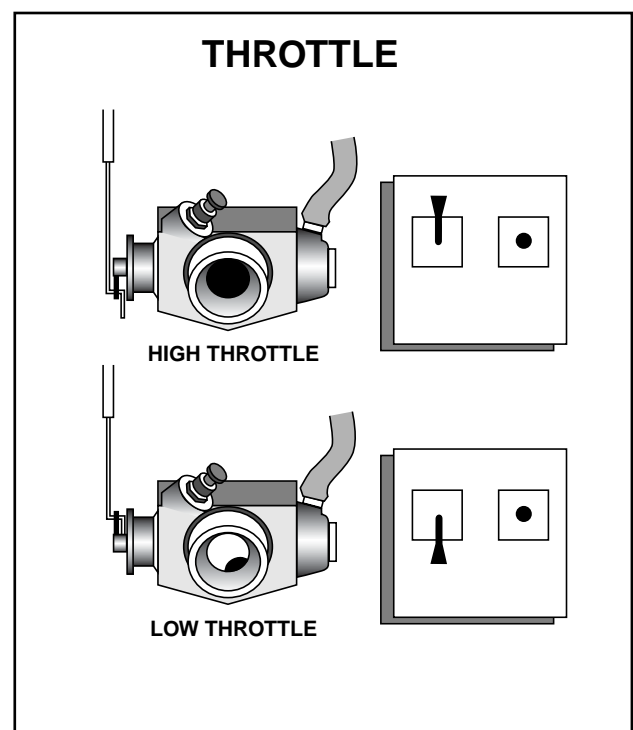
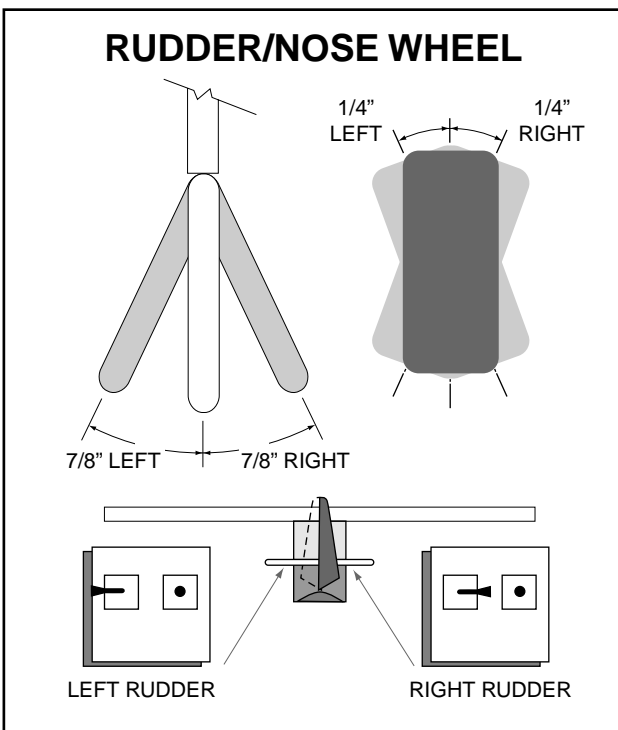
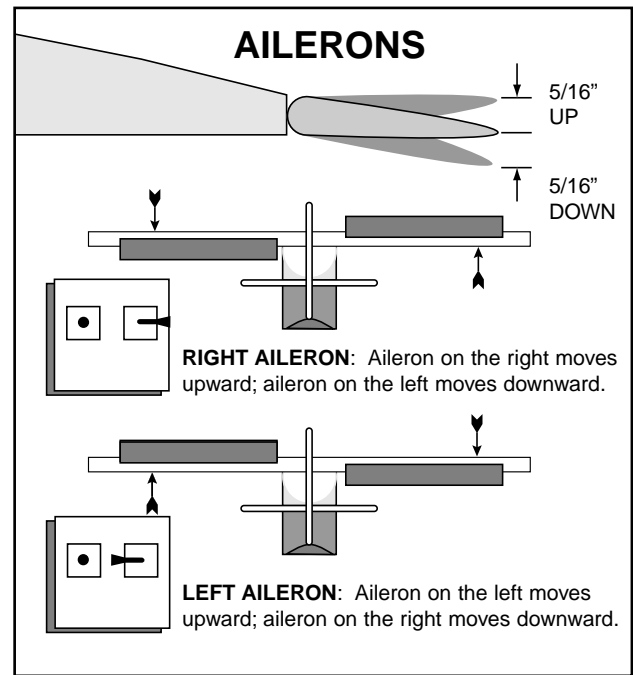
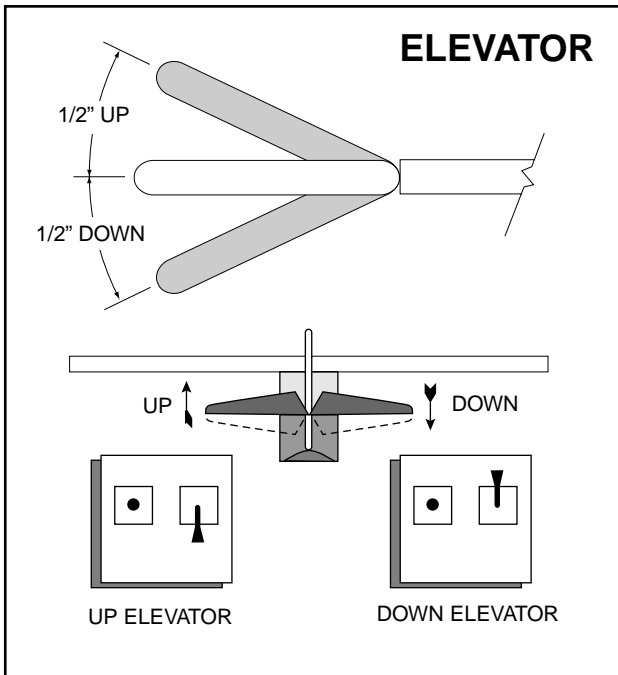

□ Adjust the linkages so you get the proper amount and direction of control throws as illustrated. To INCREASE the amount of movement, move the linkage outward on the servo arm OR inward on the control horn. To DECREASE the amount of movement, move the linkage inward on the servo arm OR outward on the control horn.

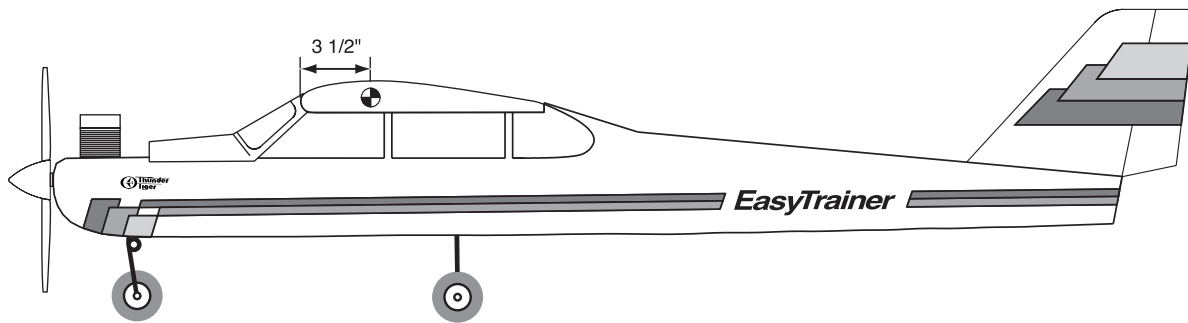

BALANCING YOUR PLANE

IMPORTANT- Do not attempt to fly your model before completing this very important section. A model that is not properly balanced will be unstable and could cause serious damage and/or injury.

❑ The balance point for this model is 3 1/2" behind the leading edge of the wing. Measure this distance and mark it on both sides of the fuselage right under the wing. With your model fully assembled but without fuel, pick it up with your index fingers at each of the two balance marks you made earlier. If balanced properly, the plane will hang horizontally. If the plane hangs with the tail down, then you need to add (or redistribute) some weight in the nose. Usually the plane will either balance or hang slightly tail heavy. The easiest cure for a tail heavy plane is to move the receiver and battery forward as far as possible. If the plane hangs nose down, then you need to add some weight to the tail. Stick-on lead weights are available from your hobby dealer that will make adding weight a simple task. Once you have everything positioned as necessary, wrap your receiver and battery pack in 1/4" or 1/2" thick foam for protection.

PRE-FLIGHT

If you are an experienced pilot, some of the following text will not apply to you. Simply disregard references to "your first flights."

LOCATE A GOOD FLYING SITE

Generally, the best place to fly your model is at an **AMA** (Academy of Model Aeronautics) chartered club field. Your local hobby dealer can tell you if there is such a club in your area or write the AMA for information. It is also a good idea to join this organization before flying your model since they offer liability insurance that can protect you if your model causes damage or injury to others.

Academy of Model Aeronautics
5151 East Memorial Dr.
Muncie, IN 47302-9252

If there is not a chartered club field in your community, you will need to find a large area free of obstructions, that has a smooth grass or asphalt surface to be used as a runway. For safety's sake, it should be located well away from houses, building, schools, power lines and airports. If you will be flying within 6 mile of an airport, you should check with the airport manager before flying your model.

A NOTE ON BATTERIES

The batteries are the heart of your radio system. Make sure you have fully charged batteries! With rechargeable batteries, follow the manufacturers instructions to make sure the batteries are fully charged, especially the first time the radio is used.

If your radio uses dry cells, make sure your batteries are in new condition. You have a lot of money invested in this project so it is not worth the risk of using old batteries.

PRE-FLIGHT CHECKS

You should perform these checks before each flying session.

- 1. Check all control surfaces for possible looseness or deterioration.
- 2. Check all screws, rubber band, clevises, nuts and all other connectors to make sure they are securely fastened.
- 3. Check which radio frequencies are being used. Do not turn on your radio until absolutely sure you are the only one operating on that frequency.
- 4. Check for proper operation of all control surfaces.
- 5. Check the level of charge in both the transmitter and receiver batteries before flying.
- 6. Range check the radio both with and without the engine running! Follow the radio manufacturers instructions for this.

FLYING

Learning to fly a radio control aircraft can be very exciting, but it is important that you thoroughly understand the basics of flight and controls before you attempt your first flights. Therefore, we highly recommend that you seek the expertise of an experienced instructor pilot for the first few flights. He (or she) can get you

in the air much more smoothly than trying everything yourself for the first time.

GETTING ORIENTED

We recommend that you find a large smooth and clear surface to practice taxiing your airplane around in before you try a take off. To taxi, you only need to use the rudder stick. At the slow speeds encountered during taxiing, the elevator and ailerons will not be effective.

The first and most important thing to remember when controlling model aircraft is: the model controls are set up to operate as if you were sitting in the cockpit of the model. This means that when you pull back (down) on the elevator stick the nose of the plane will go up. Moving the rudder stick to the right will "yaw" the plane to the right and moving the aileron stick to the right will "roll" the plane to the right. Pretty simple right? Well, not quite. Since you are really standing on the ground and not sitting in the plane, this is how the controls work when you are facing the same direction the plane is flying. The problem is that when the plane is flying towards you, the rudder and aileron controls seem reversed to the inexperienced pilot. This is the reason we recommend that you practice taxiing around in a large open area to try and get used to the control reversal.

During your first few flights, try to face the direction that the plane is flying and looking over your shoulder as needed. This makes it a little easier to pretend that your sitting in the cockpit.

FIRST FLIGHT

When you are comfortable with the controls, you should be ready for your first flight. Go over the Pre-Flight Check List one more time for good measure and taxi out the runway (hopefully with an experienced pilot by your side). Point the model directly into the wind and gradually increase the throttle to full throttle. As the model starts rolling forward it may try to turn to the left due to the engine torque. Apply enough right rudder to keep the plane rolling relatively

straight into the wind. If you built the model with right thrust, this tendency may not be noticeable. As the plane picks up speed, the right rudder input can be reduced.

Once the plane reaches flying speed, it will probably try to fly by itself. If the grass seems to be impeding takeoff, a very slight amount of “up” elevator can be applied, but it is very important that you do not apply too much up elevator too early or the plane will stall and roll over into the ground.

As the plane becomes airborne, reduce the “up” elevator and allow the plane to pick up flying speed while gently gaining altitude. Once a safe flying speed and altitude has been obtained, feel free to turn the airplane back toward the flying field. Make all control inputs smoothly and gradually so you can see the effect they have on the plane. A small amount of “up” elevator will need to be applied to keep the plane level during turns. You should be able to reduce the throttle to about 1/2 throttle for normal cruising flight which will reduce the flying speed and give you more time to think about what is going on. You will find that once airborne, you can fly the plane with only the aileron and elevator sticks. This is perfectly fine and will make it much easier for you to learn.

If the plane has a tendency to turn, roll, climb, or dive, you can adjust the transmitter trims to correct this. On your first flights, it might be a good idea to have an experienced pilot make the adjustments for you while you fly the plane.

If you get disoriented or the plane gets out of control, simply take your hands off all the controls and allow the plane to stabilize. Clear your head and try to picture yourself sitting in the cockpit. Then input the required control movements to get the plane back on the correct flight path. If you run out of time or flying space and realize the plane is going to hit something (ground, tree, etc), pull the throttle back to idle and pull the elevator stick back about half way. This will reduce the speed of the plane and minimize the damage sustained.

When you are ready to land, do a couple of slow

fly-bys at a safe altitude to get familiar with the plane’s slow-flying characteristics. An important factor to remember here is that you should regulate your altitude with the throttle not the elevator as you might expect. Practice raising the nose of plane slightly with a touch of “up” elevator and then using the throttle to regulate the plane’s altitude. When you are ready to land, fly downwind past the runway. When the plane is a hundred yards or so downwind, reduce the throttle to almost an idle and turn 90 degrees towards the runway. Fly straight for a second or two until the plane is almost even with the runway. Turn 90 degrees again and fly directly toward the runway using the throttle to govern how quickly the plane is descending. Keep the nose of plane up slightly with the elevator and allow the plane to fly gently onto the runway. Do not try to stretch the glide path without increasing the throttle or the plane may stall.

POST-FLIGHT CHECK LIST

- 1. Be sure that both the transmitter and receiver switches are turned off.
- 2. Drain all excess fuel from the tank. Fuel left in the tank for extended periods can “gunk up” the tank, fittings and carburetor.
- 3. Clean the plane with paper towels and a light-duty spray cleanser. Keeping your plane clean will make it last longer and keep it looking nice.
- 4. Put a few drops of after-run or light oil in the carburetor and turn the prop over a few times (without the glow plug ignited) to distribute the oil throughout the engine.
- 5. Inspect the prop and replace it if any chips or cracks are found.
- 6. Inspect the entire plane for covering tears, new dings and dents, loose screws and connectors and any other wear and tear.
- 7. Use a voltmeter to check the receiver battery voltage. If it is low, you now know not to fly so long next time. If it is still high, you should be able to fly a little longer next session.

SAFETY PRECAUTIONS

1. Wear safety glasses when starting and running all model engines.
2. Model engine fuel is very flammable and the flame is very dangerous because it is almost invisible! Do not smoke or allow sparks, high heat or other flames near the fuel.
3. Do not run model engines inside a garage or other closed room as they give off large amounts of deadly carbon monoxide gas.
4. Do not run model engines around gravel, sand or other loose debris. These materials will be ingested through the carburetor and can also be kicked up by the prop.
5. Always stay behind the propeller when the engine is running. Make all engine adjustments from behind the engine. Under no circumstances should you allow your face or body near the plane on rotation of the propeller when the engine is running.
6. Do not allow loose clothing or other loose objects close to the prop.
7. To stop an engine, cut off the fuel or air supply to the engine. Do not throw rags or other objects into the prop to stop the engine.
8. Do not touch the engine or muffler during or right after it has been running—It gets very hot!
9. If you hear any unusual noises while your plane is flying, land at once and determine the problem before returning to the air. Control surface flutter, which often emits a low-pitched “buzz”, can quickly destroy an airplane and should not be ignored. Flutter is usually caused by sloppy control surfaces and is generally relatively easy to cure.

ACCESSORIES FOR YOUR PEGASUS

TTR3002 SIDE KICK



All you need to start your engine except fuel.

TTR2674 HD90 STARTER



Save your flipping finger!

ACE2526 ACE CVC



Safe charging for your 12V battery.

ACE2915 ACE POWER 12V BATTERY

